

1

Fold in the dotted lines to meet the center line

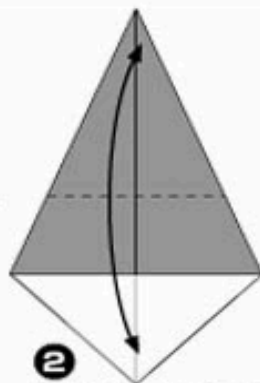

2

Fold in half to make a crease and fold back

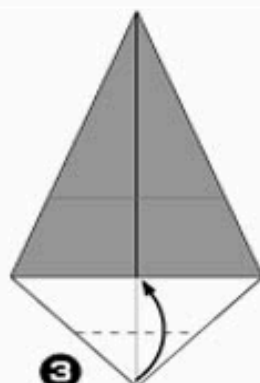

3

Fold in the dotted line

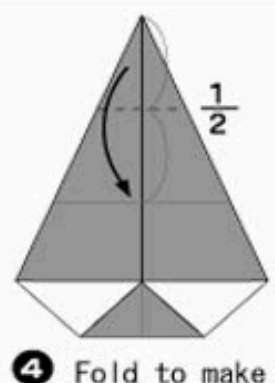

4

Fold to make a crease and unfold

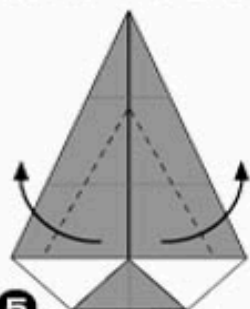

5

Fold in the dotted lines

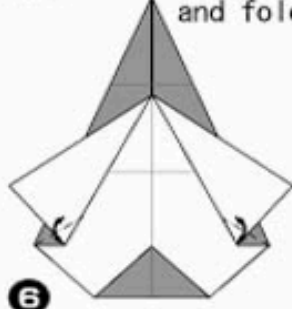

6

Fold to make creases and unfold

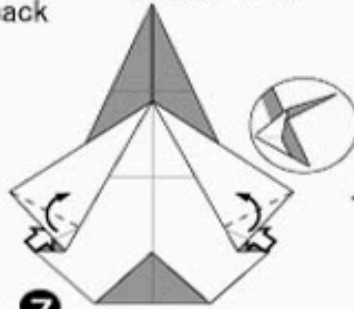

7

Open the pockets from 

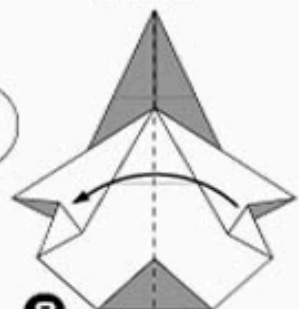

8

Fold in half



9

Fold to make a crease and unfold



10

Fold to make a crease and unfold

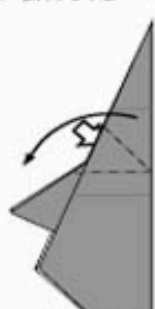

11

Open the pocket from 

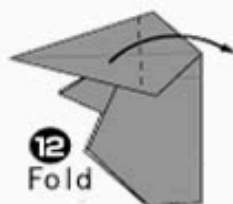

12

Fold

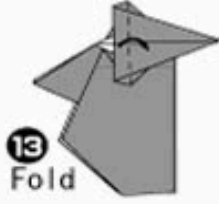

13

Fold



14

Turn around

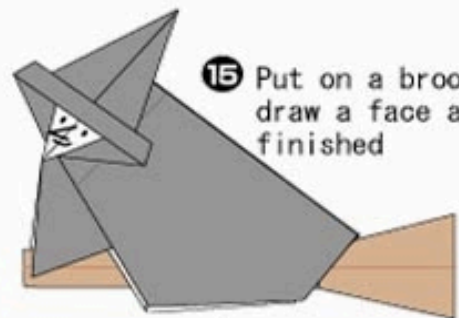

15

Put on a broom, draw a face and finished

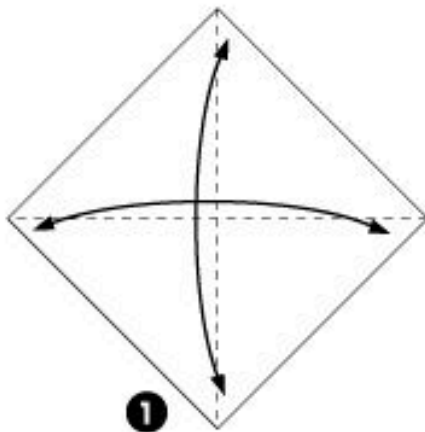

1
Fold in the dotted lines
to make creases
and fold back

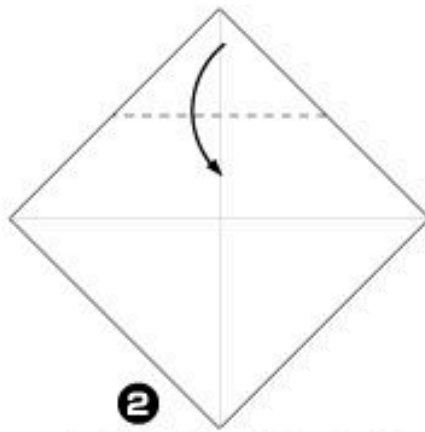

2
Fold in the dotted line

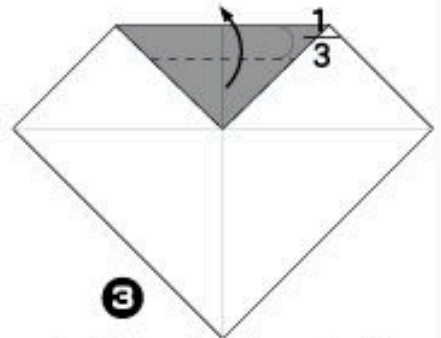

3
Fold in the dotted line

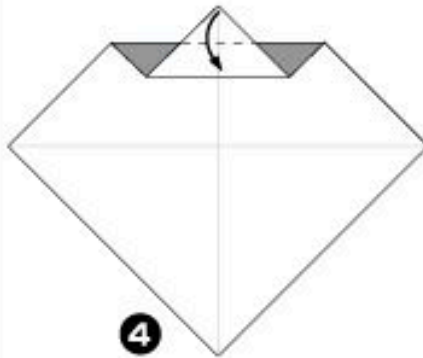

4
Fold in the dotted line

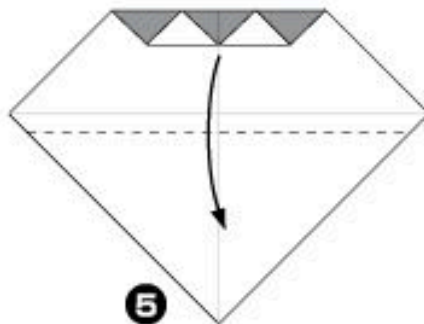

5
Fold in the dotted line

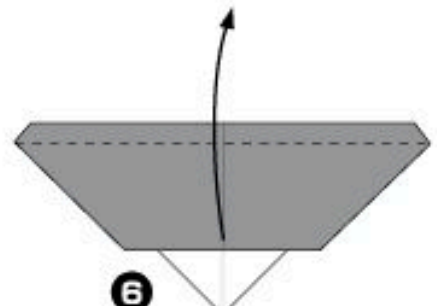

6
Fold in the dotted line

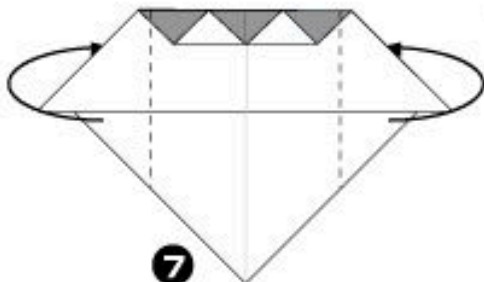

7
Fold backward
in the dotted line

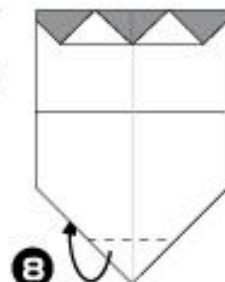

8
Fold backward
in the dotted line

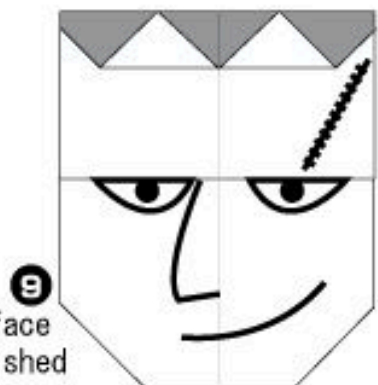

9
Draw a face
and finished

A Frankenstein (face)

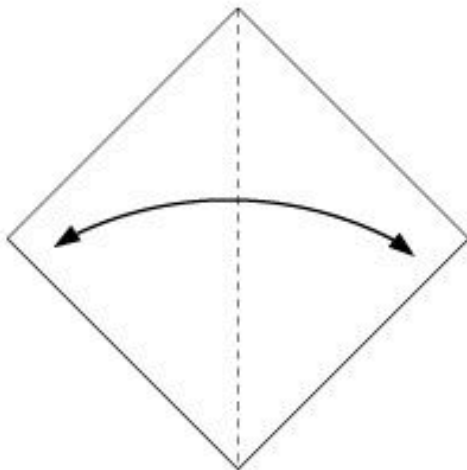

1 Fold in half to make

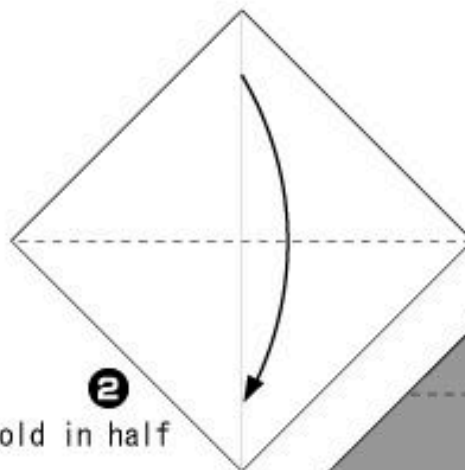

2
Fold in half

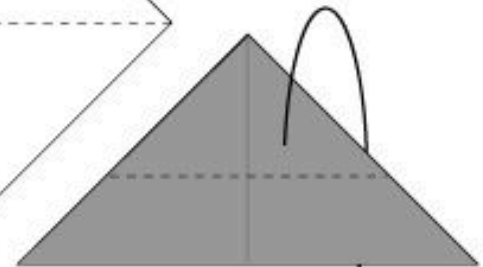

3 Fold backward in the dotted line

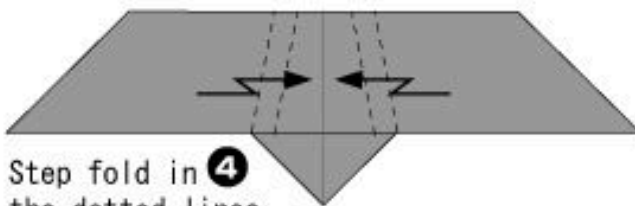
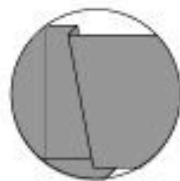

Step fold in **4**
the dotted lines

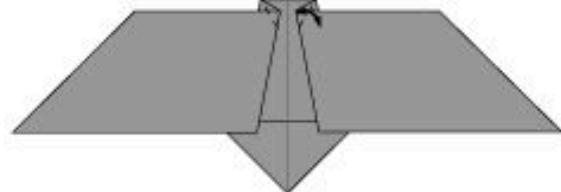
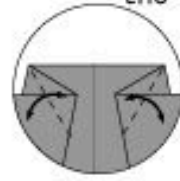

5 Fold to make crease and fold back

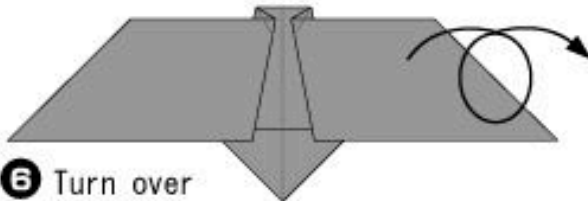

6 Turn over

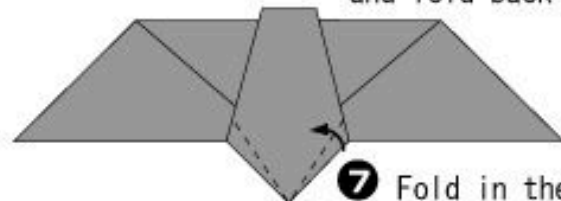

7 Fold in the dotted lines

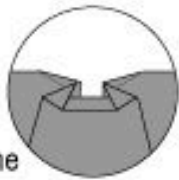

8 Fold in the dotted line

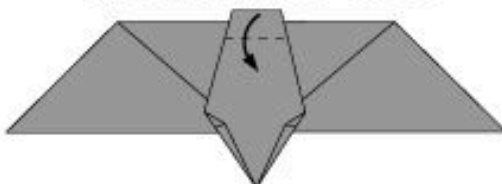

Finished **9**

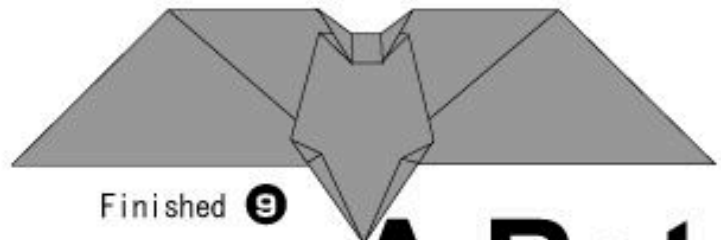

A Bat

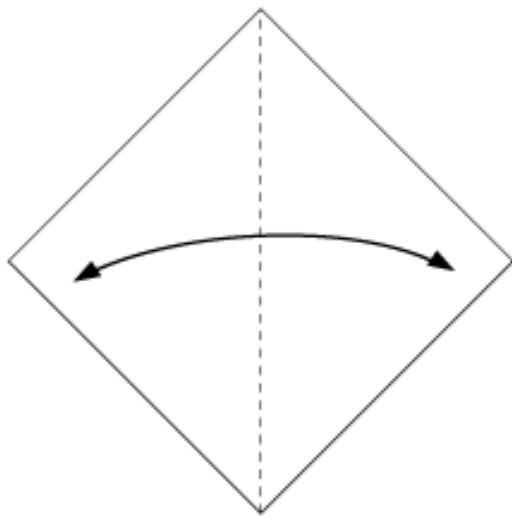

1 Fold in half to make a crease and unfold

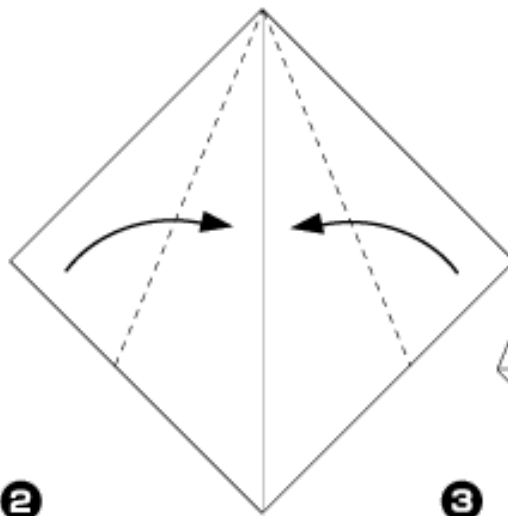

2 Fold in the dotted lines to meet the center

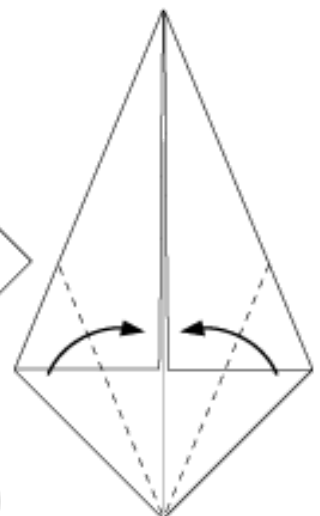

3 Fold in the dotted lines to meet the center



4 Open the pocket from 

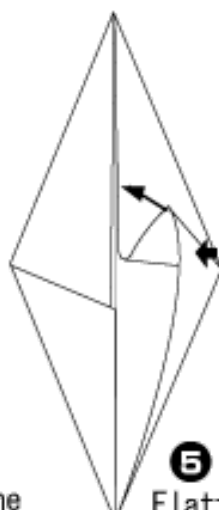

5 Flatten the both pockets

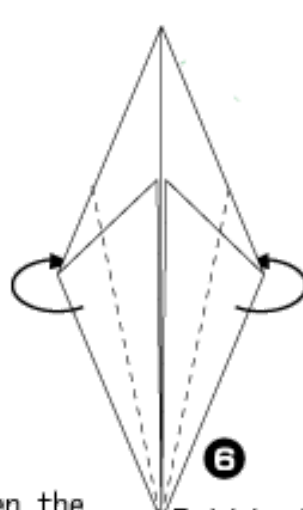

6 Fold backward in the dotted lines



7 Fold in the dotted line



8 Fold backward



9 Fold backward

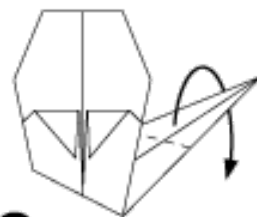

10 Fold backward



11 Draw a face and finished

A Ghost

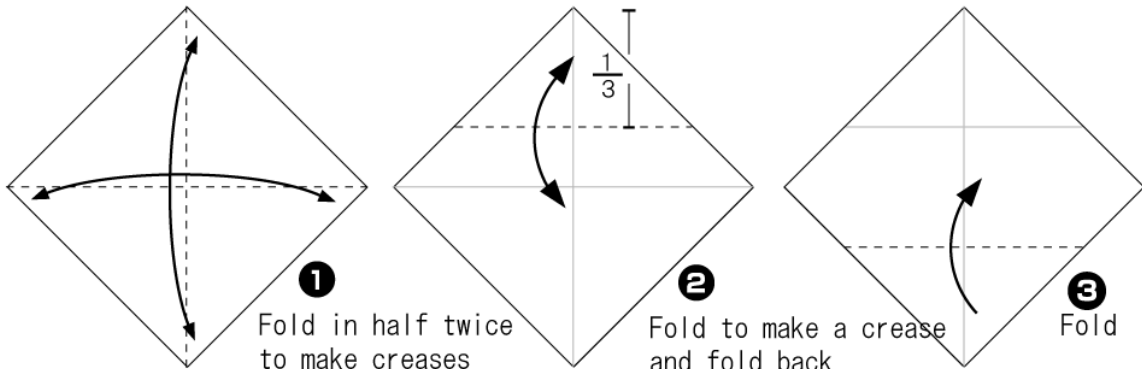

1

Fold in half twice to make creases and fold back

2

Fold to make a crease and fold back

3

Fold

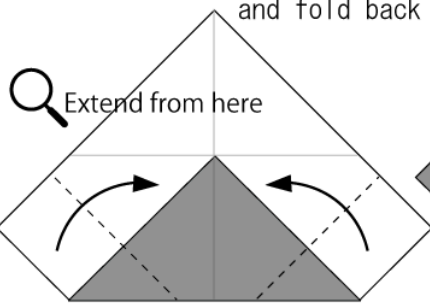

Extend from here

4

Fold

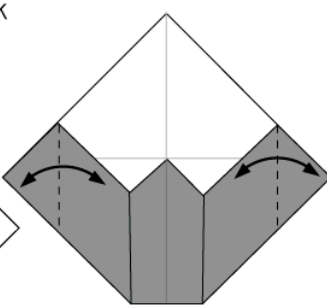

5 Fold to make a crease and fold back

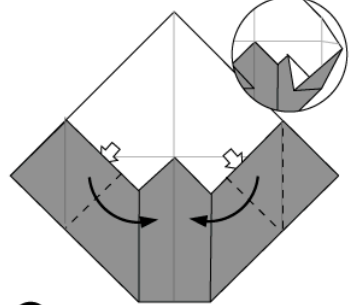

6 Open the \uparrow part and flatten

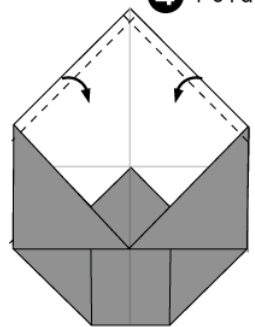

7 Fold

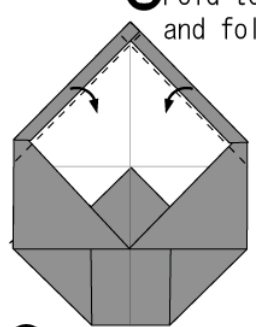

8 Fold

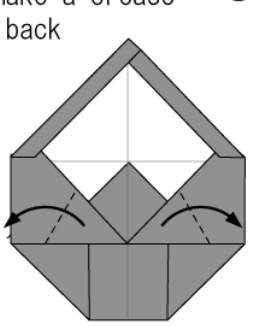

9 Fold

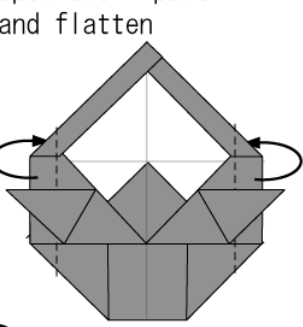

10 Fold backward

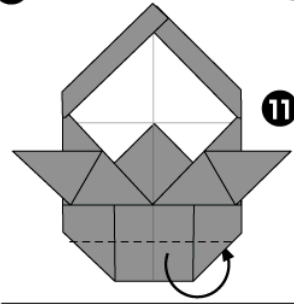

11 Fold backward

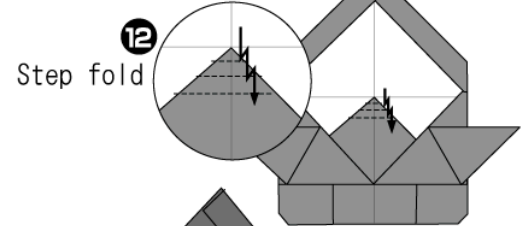

12 Step fold

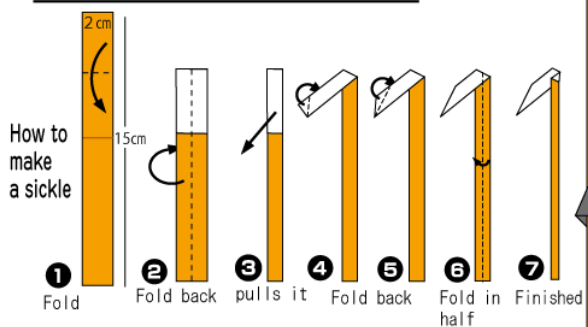

How to make a sickle

1 Fold **2** Fold back **3** pulls it **4** Fold back **5** Fold back **6** Fold in half **7** Finished

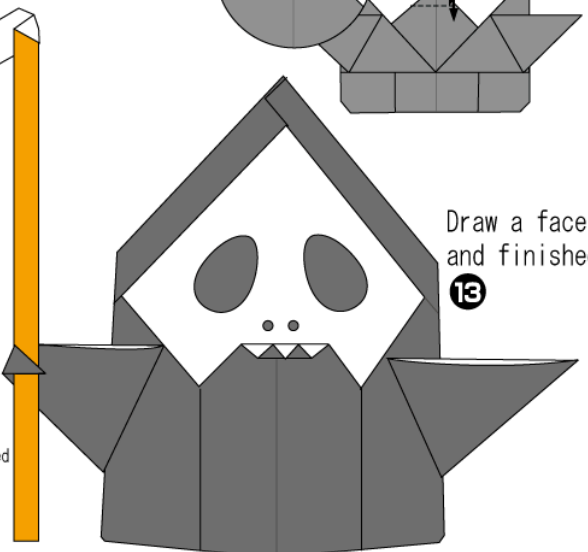

Draw a face and finished

13



ORIGAMI CLUB
 For more origami diagrams
en.origami-club.com
 ©Copyright: Fumiaki Shingu

Skeleton ghost